

# STS 4000

## Multifunction Substation Test Set



## Multifunction Substation Maintenance & Commissioning Test System for Current, Voltage and Power Transformers

### Capacitance - Tan Delta Diagnostic System with the optional module TD 5000

- Fully automatic
- Primary injection testing capabilities: up to 7000 with the optional module BUX
- Variable output frequency: 15÷500 Hz
- Power dissipation factor test with the optional module TD 5000 ( voltage up to 12 kV)
- 2000 V AC high-pot test
- Local control by large graphic display
- Tan Delta test on rotative machines (generators and motors)
- PADS - Power Apparatus Diagnostic Software for automatic testing, assessment and report
- IEC 61850-9-2 communication protocol
- USB interface and Ethernet interface for PC connection
- Compact and lightweight
- Patented technology for capacitance and Tan Delta measurement

#### LEGENDA:



BUX 2000 - BUX 3000 - BUX 5000  
HIGH CURRENT BOOSTERS



20A DC BOOSTER FOR  
WINDING RESISTANCE TEST



STDE POWER TRANSFORMER  
DEMAGNETIZER

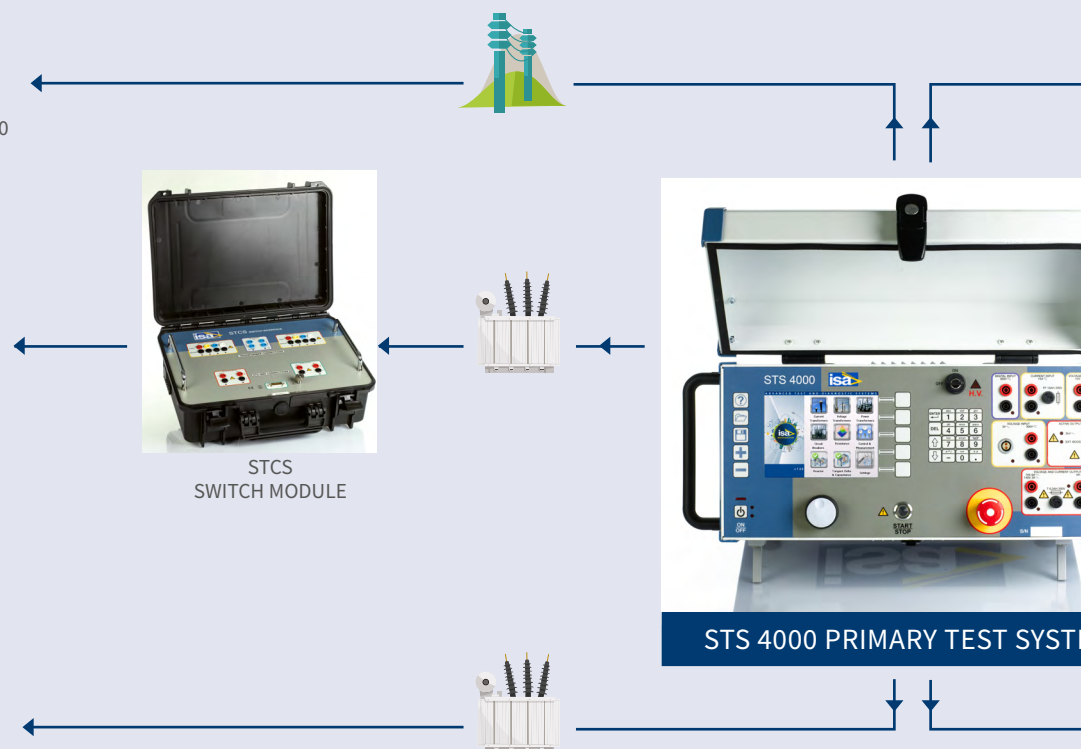

## Application

The following table lists the tests that can be performed on CTs, VTs, PTs and ground grid.

N.	TEST	TEST DESCRIPTION
1	CT	Ratio, Voltage mode
2	CT	Ratio, polarity and burden with high AC current*
3	CT	Burden, secondary side; ALF/ISF
4	CT	Excitation curve
5	CT	Winding or burden resistance
6	CT	Voltage withstand
7	CT	Rogowski coil transformers
8	CT	Low power transformers
9	CT	Tan Delta measurements
10	VT	Ratio; polarity
11	VT	Burden, secondary side
12	VT	Ratio, electronic transformers
13	VT	Voltage withstand
14	VT	Remote polarity check
15	VT	Tan Delta measurements

\* with the optional module BUX 2000, BUX 3000 or BUX 5000.

N.	TEST	TEST DESCRIPTION
16	PT	Ratio per TAP
17	PT	Vector group
18	PT	Static and dynamic resistance of Tap Changer contacts
19	PT	No-load current
20	PT	Short-circuit impedance
21	PT	Tan Delta measurements
22	CB	Tan Delta measurements
23	CB, RELAY	Current threshold and timing*
24	R	Ground resistance and resistivity
25	R	Step and touch voltages
26	L	Measurement of line impedance and of the related parameters
27	Capacitor banks	Measurement of the capacitance

Tests are performed in accordance with the following IEC standards: IEC61869-2; IEC61869-3; EN 60044-1; EN 60044-2; EN 60044-5; EN 60044-7; EN 60044-8; EN 60076-1, and also in accordance with ANSI/IEEE C57.13.1. and C57.12-90. Resistance tests are performed according to the following standards: EN50522, EN61936-1, IEE80-2000, IEE81-1983, DIN VDE 0101 and CENELEC HD637 s1.

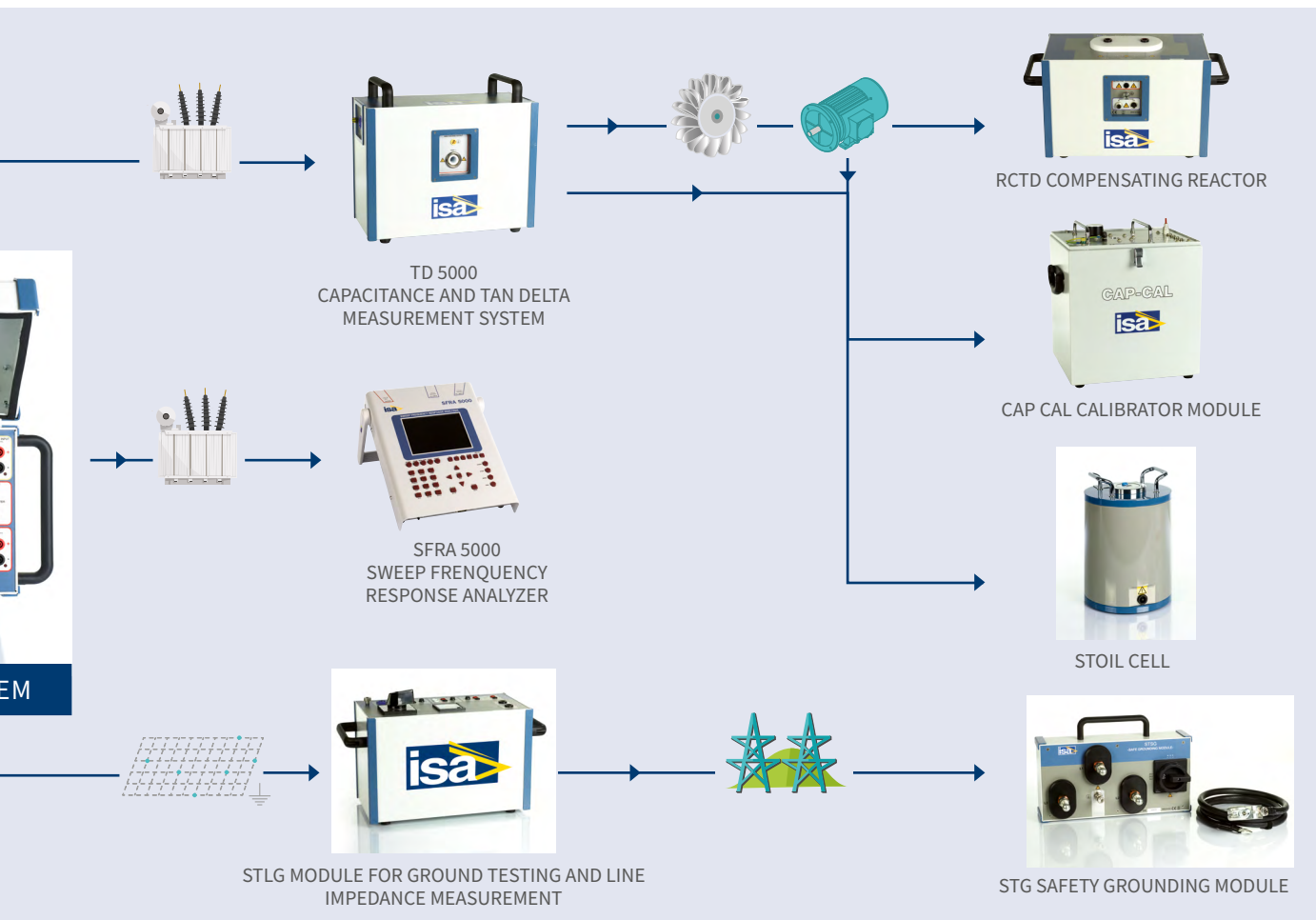

The following optional modules enhance the STS 4000 features.

- The high voltage (HV) generator TD 5000 performs the measurement of the tan Delta, capacitance and power factor of any device, at the frequency of the mains or in a wide frequency range.
- The circuit switch option STCS performs the automatic measurement of PT's turn ratio, of winding resistance and also testing the operation of the Load or no-Load Tap Changer
- The extremely high current BUX 5000, BUX 3000 and BUX 2000 options perform high current tests, with currents up to 5000 A
- The STLG module allows performing high current grid resistance and overhead lines tests.

## System Description

The STS family includes **4 models**: STS 5000, STS 4000, STS 3000 light and TDX 5000. STS 4000 is not equipped with: AC and DC high current outputs. STS 3000 light is not equipped with: AC and DC high current outputs, AC and DC high and low voltage outputs, and current and voltage meters. All models can be connected to the Tan Delta module TD 5000; STS 5000 and STS 4000 can be connected to the very high current module BUX 5000, BUX 3000 and BUX 2000. **STS 4000 includes four output generators**: low AC current; low DC current; high AC voltage; low AC voltage.

In the **local control mode**, the selected output is adjustable and metered on the large, graphic LCD display. With the control knob and the LCD display, it is possible to enter the MENU mode, that allows to set many functions, that make STS 4000 a very powerful testing device, with manual and automatic testing capabilities, and with the possibility to transfer test results to a PC via ETHERNET or Pen Drive. The TDMS software, which comes with the test set, allows to download, display and analyse test results obtained in local mode. Remote maintenance and diagnostic of the instrument is available via Ethernet. TDMS operates with all Windows® versions.

The **ease of operation** has been the first goal of STS 4000. This is why the LCD display is so large and the dialogue in MENU mode is made easy. Connection diagrams are available according with the test window. STS 4000 includes three measurement inputs:

- DC voltage (10 V DC)
- AC voltage:
  - High range (300 V AC) - Low range (3 V AC)
- Current (10 A AC or DC)

All these inputs are independent among them and allow the measurement of CT or VT outputs or of another source.

In addition, a digital input (up to 300 V) is available: it can measure the timing of a wet or dry contact. The instrument is housed in a transportable aluminium box, which is provided with removable cover and handles for ease of transportation. A transport trolley can also be supplied upon request.

STS 4000 can be supplied with a portable generator without loss of performances.

## IEC 61850-9-2 Sampled Values

STS 4000 has the facility to test CT, VT, both conventional and non conventional, Merging Unit (MU) using the IEC 61850-9-2 (SV) protocol. The STS 4000 generates current or voltage signal and injects these quantities into the CT or VT under test.

The STS 4000 then reads the data from the network (Sample Values) in order to perform a variety of different tests.

- Possibility to test CT ratio and polarity check up to 2000 A (with BUX 2000), 3000 A (with BUX 3000) or 5000/ 7000 A (with BUX 5000)
- Possibility to test VT ratio and polarity up to 2 kV
- Test of MU

## TDMS - Test & Data Management Software

TDMS, Test & Data Management Software, is a powerful software package providing data management for acceptance and maintenance testing activities. Electrical apparatus data and test results are saved in the TDMS database for historical results analysis. The TDMS database organizes test data and results for the majority of electrical apparatus tested with ISA test sets and related software.

## PADS - Power Apparatus Diagnostic Software

PADS - Power Apparatus Diagnostic Software is a powerful software application, included in TDMS software, that optionally allows the remote control of the STS family: STS 5000, STS 4000, STS 3000 light and TDX 5000. The software performs various tasks, such as:

- Control STS and TD remotely from PC
- Create test plan
- Download stored test results via Ethernet cable
- Create and customize test reports
- Print test results

This program runs under Windows® environment.

**Note: Windows is trademark of Microsoft Corporation.**

STS 4000 - Front Panel

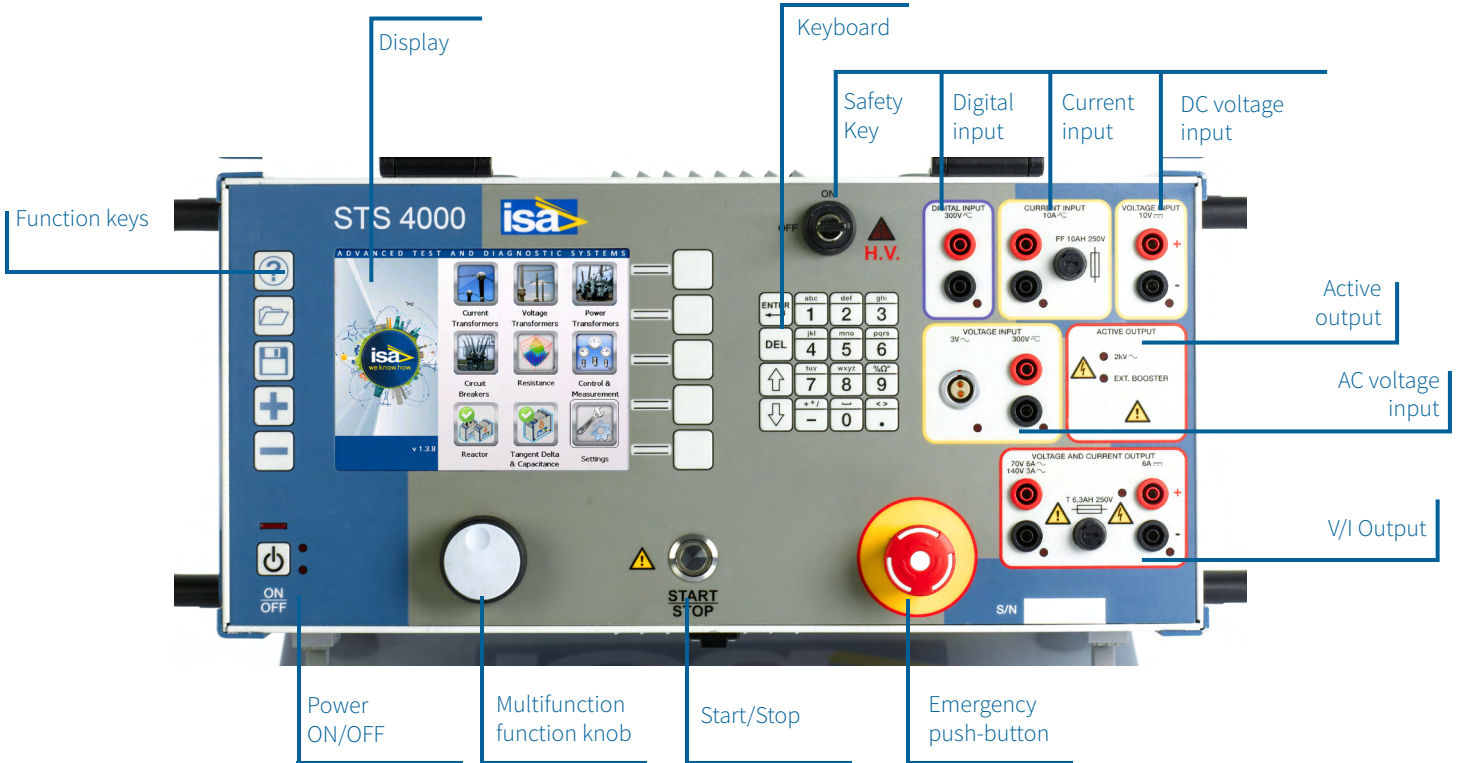

STS 4000 - Side Panels

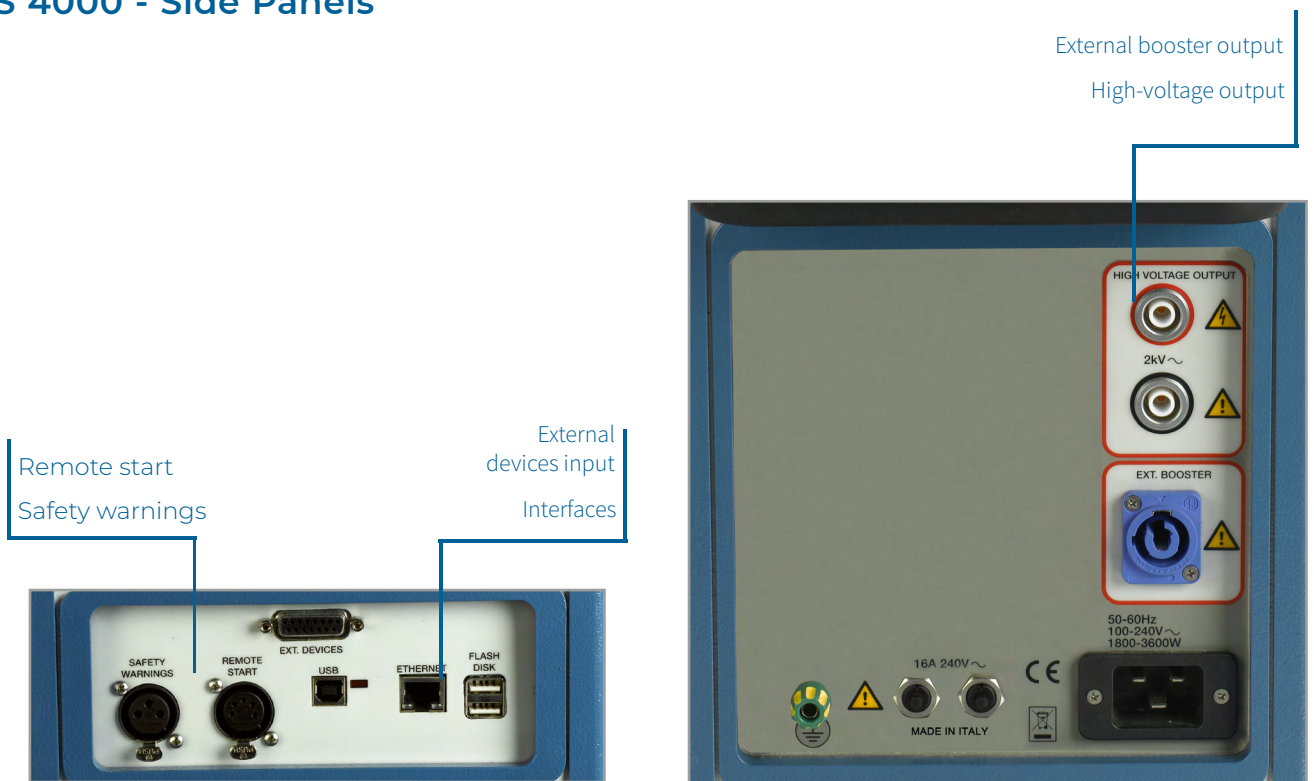

## Test Plan Editor

**Test Plan Editor** is an innovative and advanced software module allowing the operator to define and plan a sequence of tests. The operator defines the desired sequence of tests and sets the parameters of each test.

**Test Plan Editor** creates a sequence of tests to be performed automatically. This feature is available for the test of current, voltage and power transformers. It is also possible to create a test sequence for primary and secondary injection.

Test plans can be saved or recalled, like test results. Up to 64 settings can be stored and recalled. Settings are permanently

stored in the memory and new settings can be written to the same address after confirmation. During the test, test results can be stored in the memory. At the end of test, settings and test results can be transmitted to a PC provided with TDMS.

The software allows saving, exporting and analysing test results.

### Example of Test Plan Editor for CT Tests

#	Name	I Prim (A)	Nom. Ik (A)	Nom Vk (V)
1	1S1-1S2	800.0	50.000m	400.000
2	1S1-1S3	400.0	50.000m	200.000
3	1S1-1S4	200.0	50.000m	100.000
4	1S1-1S5	100.0	50.000m	50.000

**Nominal values window:** from these nominal data, the program computes the nominal saturation knee

**Tests header window:** test reference data

**Tolerances window** allows setting the tolerances for each of the available tests

Test Type	Tap #	Exe	Pass/Fail
Manual Measure		<input checked="" type="checkbox"/>	<span style="color: green;">●</span>
Ratio Polarity and Burden	1-4	<input checked="" type="checkbox"/>	<span style="color: red;">●</span>
Burden Secondary Side	1-4	<input checked="" type="checkbox"/>	<span style="color: green;">●</span>
Excitation Curve	1-4	<input checked="" type="checkbox"/>	<span style="color: green;">●</span>
Winding or Burden Resistance	1-4	<input checked="" type="checkbox"/>	<span style="color: red;">●</span>
Voltage Withstand		<input checked="" type="checkbox"/>	<span style="color: green;">●</span>
Polarity Check		<input checked="" type="checkbox"/>	<span style="color: green;">●</span>
Ratio Polarity Voltage Mode	1-4	<input checked="" type="checkbox"/>	<span style="color: red;">●</span>
Rogowski (Ratio)		<input checked="" type="checkbox"/>	<span style="color: green;">●</span>
Low Power (Ratio)		<input checked="" type="checkbox"/>	<span style="color: yellow;">●</span>
Tangent $\delta$			

**Test selection window:** it allows selecting the test to be performed

At the end of the programming, starting the first test will execute the complete sequence. During the test, test results are stored in the memory. The test set minimizes the test duration, in order to avoid over-heating the components. The same feature is available when controlling the test set via PC by PADS.

## Test of Current Transformer

### CT Ratio and Polarity Voltage Method

The ratio measurement is performed applying high-voltage AC to the CT secondary and measuring the CT primary voltage. Input parameters are: the nominal primary and secondary current, from which the program computes the nominal ratio, the voltage range, the nominal test voltage and the test frequency. The display shows:

- The voltage output, the secondary voltage and the current during the test
- Actual ratio and ratio error
- Phase shift and polarity

### CT Ratio and Burden Current Method

The ratio measurement is performed applying high current to the CT primary and measuring the CT secondary current. The burden can be by-passed or left in series for the measurement. In this instance, the voltage drop is measured. The secondary current can be measured by a clamp. Input parameters are: the nominal primary and secondary current, from which the program computes the nominal ratio and the nominal test current. The display shows:

- The actual primary current
- The corresponding secondary current
- The value of the secondary current with the nominal primary current
- Actual ratio and ratio error
- Phase shift and polarity

When the burden is tested, the following parameters are displayed:

- The voltage drop across the burden
- For the burden: VA rating at the nominal current, angle and power factor

### CT Burden Secondary Side

The burden measurement is performed applying low AC current to the CT burden and measuring the voltage drop.

Input parameters are: the nominal secondary current and the nominal test current. The display shows:

- The actual current output
- The voltage drop across the burden
- For the burden: VA rating at the nominal current, angle and power factor
- The actual ALF/ISF

## CT Excitation Curve

The excitation curve is tested connecting the high AC voltage to the CT secondary, ramping the voltage and measuring at the meantime the output current and voltage.

Input parameters are taken from the CT nominal value window. Other inputs are: maximum test voltage, maximum current and test frequency. The test set controls the output voltage and current during the test and stops as the knee is recognized. The display shows:

- The characteristic curve
- The actual voltage knee and the error with respect to the nominal
- The actual current error at knee

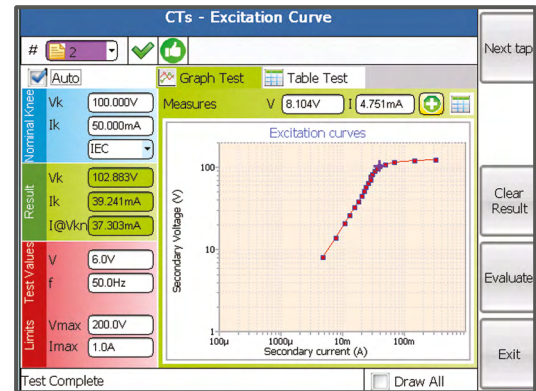

## Winding Resistance

The resistance (not impedance) is measured connecting the low DC current source to the winding or burden, and measuring the test current and the voltage drop. Input parameters are: the nominal resistance, the connected output, the test current and the resistance limits.

It is also possible to compensate the test temperature. The test set controls the output current and voltage during the test, and stops as the test current is reached. The display shows:

- The test current
- The voltage drop
- The measured resistance and the compensated resistance
- The test duration and the current deviation when the measurement was achieved

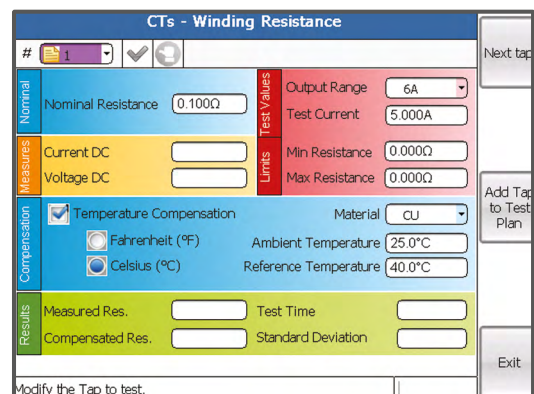

## Voltage Withstand

The test is performed connecting the high AC voltage source between the CT secondary cabling and the ground.

Input parameters are: maximum test current (with automatic switch-off), test time, output range, test voltage, test frequency.

The display shows:

- During the HV ramping, the test voltage and current
- As the test is completed, the maximum current, the total elapsed time and the isolation impedance

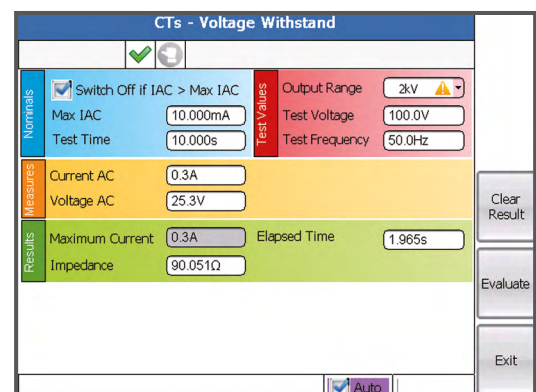



### Rogowski Coil

The test is performed connecting the high AC current source to the primary side, and connecting the CT secondary side to the low-voltage measurement. Input parameters are: the nominal primary current and the nominal secondary voltage, from which the program computes the nominal ratio, the current range, the test current and the test frequency.

The display shows:

- The range current and the test current
- The actual test current, the secondary voltage and the value of the primary current with the nominal secondary voltage
- Actual ratio and ratio error
- Phase shift and polarity

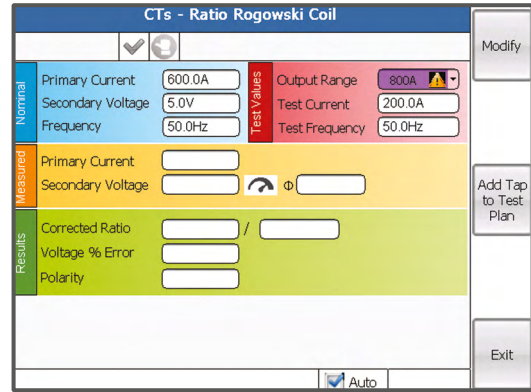

### Low Power

The test is performed connecting the high AC current source to the primary side and connecting the CT secondary side to the low-voltage measurement. Input parameters are: the nominal primary current and the nominal secondary voltage, from which the program computes the nominal ratio, the current range, the test current and the test frequency.

The display shows:

- The range current and the test current
- The actual test current, the secondary voltage and the value of the primary current with the nominal secondary voltage
- Actual ratio and ratio error
- Phase shift and polarity

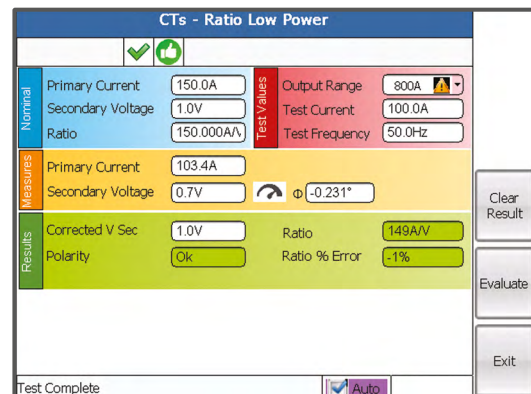

### Power Factor, Capacitance and Tan Delta

With TD 5000 optional module

The test is performed using the TD 5000 optional module, and then connecting the high AC voltage source to test target.

Input parameters are: Winding, test voltage and frequency, test mode, and the nominal capacitance, PF, DF.

The display shows the following data:

- Test voltage, current and frequency
- Capacitance
- Tan Delta and power factor (absolute or percentage values)
- Power data: active, reactive and apparent
- Impedance: module, argument and components

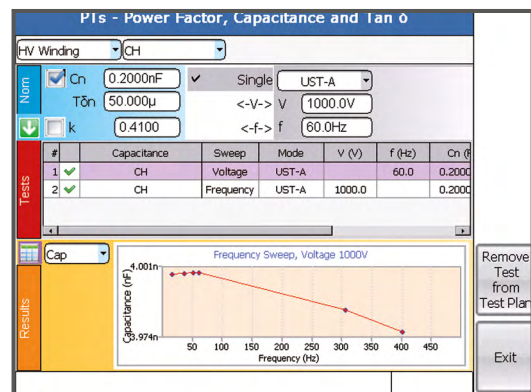

## Test of Voltage Transformer

### VT Ratio and Polarity

The ratio measurement is performed by applying high voltage to the VT primary and measuring the VT secondary voltage. Input parameters are: the nominal primary and secondary voltage, from which the program computes the nominal ratio, type of connection (Y or Delta), the HV range, the nominal test voltage and frequency and the selected voltage meter. The display shows:

- The actual test voltage
- The secondary voltage
- The value of the secondary voltage with the nominal primary voltage
- Actual ratio and ratio error
- Phase shift and polarity

Voltage Transformer - Ratio			
Nominal		Primary Voltage: 2000.0V LL <input type="radio"/> LN <input checked="" type="radio"/>	Output Range: 500V ⚠ Test Voltage: 200.0V Test Frequency: 50.0Hz
Measured		Secondary Voltage: 20.00V LL <input type="radio"/> LN <input checked="" type="radio"/> OD <input type="radio"/>	V in: <input checked="" type="radio"/> 300V <input type="radio"/> 3V
Results		Ratio: 100.000	Phase Shift: $\phi$ 2.3°
		Primary Voltage: 219.283V	Secondary Voltage: 2.157V
		Corrected V Sec: 19.672V	Ratio: 101.667
		Polarity: Ok	Ratio % Error: 1.67%
Test Complete <input checked="" type="checkbox"/> Auto			

### VT Burden

The burden measurement is performed by applying low AC voltage to the VT burden and measuring the corresponding current. Input parameters are: the nominal secondary voltage, the voltage range, the test voltage and frequency. The display shows:

- The actual voltage output
- The output current
- For the burden: VA rating at the nominal voltage, angle and power factor

Voltage Transformer - Burden			
Nominal		Secondary Voltage: 6.7V LL <input type="radio"/> LN <input checked="" type="radio"/> OD <input type="radio"/>	Output Range: 140V Test Voltage: 100.0V Test Frequency: 50.0Hz
Measured		Secondary Voltage: 85.3A Secondary Current: 0.0°	Phase Shift: $\phi$ -1.0°
Results		Current Clamp: <input type="checkbox"/> 10.0A / 1.0V	Input: 10A
		Burden: 0.000VA	cos $\phi$ : 1.000°
Test Complete <input checked="" type="checkbox"/> Auto			

### Ratio of Electronic Transformer

The ratio measurement is performed by applying high voltage to the VT primary, and measuring the low-level VT secondary voltage. Input parameters are: the nominal primary and secondary voltage, from which the program computes the nominal ratio, type of connection (Y or Delta), the HV range, the nominal test voltage and frequency. The display shows:

- The actual test voltage
- The secondary voltage
- The value of the secondary voltage with the nominal primary voltage
- Actual ratio and ratio error
- Phase shift and polarity

Voltage Transformer - Ratio Electronics			
Nominal		Primary Voltage: 2000.0V LL <input type="radio"/> LN <input checked="" type="radio"/>	Output Range: 2kV ⚠ Test Voltage: 200.0V Test Frequency: 50.0Hz
Measured		Secondary Voltage: 6.66V LL <input type="radio"/> LN <input checked="" type="radio"/> OD <input type="radio"/>	
Results		Ratio: 300.300	Phase Shift: $\phi$ 1.2°
		Primary Voltage: 218.416V	Secondary Voltage: 0.708V
		Corrected V Sec: 6.479V	Ratio: 308.681
		Polarity: Ok	Ratio % Error: 2.79%
Test Complete <input checked="" type="checkbox"/> Auto			

### Voltage Withstand

The test is performed connecting the high AC voltage between the VT secondary cabling and the ground.

Input parameters are: maximum test current (with automatic switch-off), test time, output range, test voltage and test frequency.

The display shows:

- During the HV ramping, the test voltage and current
- As the test is completed, the maximum current, the total elapsed time and the isolation impedance

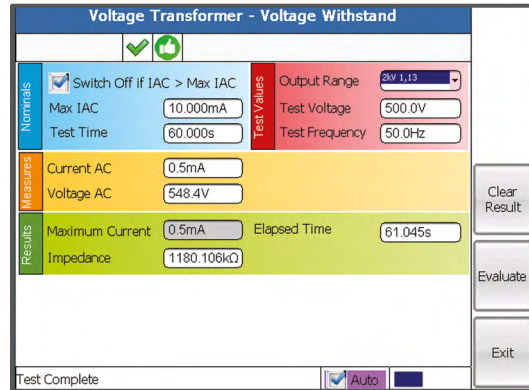

### Remote Polarity Check

The test is performed connecting the high AC voltage source to the primary side and measuring the secondary voltage, with the optional PLCK polarity sensor.

Input parameters are: the test current, the time interval and the test result (Pass/Fail). The display shows the test current and records the test result of the different points.

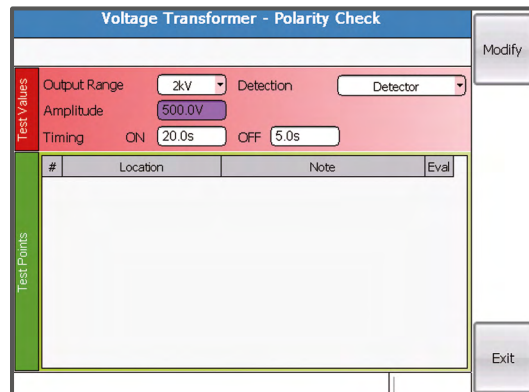

### Power Factor, Capacitance and Tan Delta

With TD 5000 optional module

The test is performed using the TD 5000 optional module and then connecting the high AC voltage source to the test target.

Input parameters are: Winding, test voltage and frequency, test mode and the nominal capacitance, PF, DF.

The display shows the following data:

- Test voltage, current and frequency
- Capacitance
- Tan Delta and power factor (absolute or percentage values)
- Power data: active, reactive and apparent
- Impedance: module, argument and components

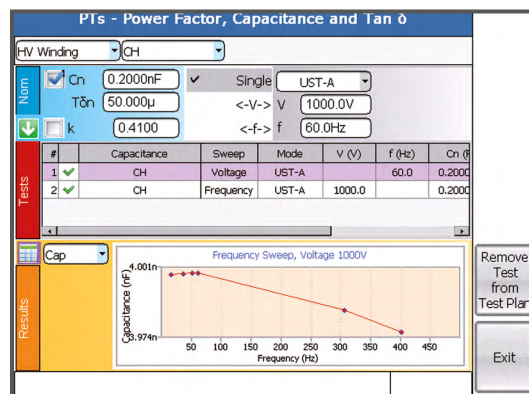

## Test of Power Transformer

### Ratio per Tap

The ratio measurement is performed applying high voltage to the PT primary and measuring the PT secondary voltage for each tap. If the STCS option is available, connection is performed via the option and the test is completely automatic. Input parameters are: the nominal primary and secondary voltage, from which the program computes the nominal ratio, type of connection (Y or Delta), the type of Tap changer, the HV range, the nominal test voltage and frequency and the selected voltage meter.

The display shows:

- The test current and angle
- The test voltage, primary and secondary
- Actual ratio and ratio error
- Phase shift and polarity

Voltage Transformer - Ratio				
<input checked="" type="checkbox"/> <input type="checkbox"/>				
Nominal	Primary Voltage	2000.0V	Output Range	500V
	LL <input type="radio"/> LN <input checked="" type="radio"/>		Test Voltage	200.0V
	Secondary Voltage	20.00V	Test Frequency	50.0Hz
	LL <input type="radio"/> LN <input checked="" type="radio"/> OD <input type="radio"/>		V in	<input checked="" type="radio"/> 300V <input type="radio"/> 3V
	Ratio	100.000		
Measured	Primary Voltage	219.283V		
	Secondary Voltage	2.157V	$\phi$ 2.3°	
Results	Corrected V Sec	19.672V	Ratio	101.667
	Polarity	Ok	Ratio % Error	1.67%
Test Complete				<input checked="" type="checkbox"/> Auto

### Vector Group

The test is performed connecting the high AC voltage source between PT primary windings, while the others are short-circuited. The test is composed by two measures of secondary windings voltage and phase shift. If the STCS option is available, connection is performed via the option and the test is completely automatic. Input parameters are: the test voltage and frequency, the nominal turn ratio, the presence of neutral winding.

The display shows:

- Test voltage and frequency
- Test connections
- Phase displacement and connection

Voltage Transformer - Burden				
<input checked="" type="checkbox"/> <input type="checkbox"/>				
Nominal	Secondary Voltage	6.7V	Output Range	140V
	LL <input type="radio"/> LN <input checked="" type="radio"/> OD <input type="radio"/>		Test Voltage	100.0V
			Test Frequency	50.0Hz
Measured	Secondary Voltage	85.3A		
	Secondary Current	0.0°	$\phi$ -1.0°	
	Current Clamp	<input type="checkbox"/> 10.0A / 1.0V	Input	10A
Results	Burden	0.000VA		
	cos $\Phi$	1.000°		
Test Complete				<input checked="" type="checkbox"/> Auto
				Clear Result
				Evaluate
				Exit

### Static and Dynamic Winding Resistance and Tap Changer Test

The test is performed applying low DC current to the PT primary plus TapChanger and measuring the voltage drop. The tester measures the resistance peak during the switch and the resistance after the selection. If the STCS option is available, the connection is performed via the option and the test is completely automatic. Input parameters are: the tap number, the type of Tap changer, the current range, the test current, the nominal resistance and the resistance limits. It is also possible to compensate the test temperature. The test set controls the output current during the test and issues the Tap Change command. The display shows:

- The test current
- The tap number
- For the static resistance: the test voltage and resistance, also compensated
- For the dynamic resistance: the measured values are the Ripple and the Slope and a graphical representation of current and resistance profiles. The dynamic resistance measurement is performed also without the STCS option.

Voltage Transformer - Ratio Electronics				
<input checked="" type="checkbox"/> <input type="checkbox"/>				
Nominal	Primary Voltage	2000.0V	Output Range	2kV
	LL <input type="radio"/> LN <input checked="" type="radio"/>		Test Voltage	200.0V
	Secondary Voltage	6.66V	Test Frequency	50.0Hz
	LL <input type="radio"/> LN <input checked="" type="radio"/> OD <input type="radio"/>			
	Ratio	300.300		
Measured	Primary Voltage	218.416V		
	Secondary Voltage	0.708V	$\phi$ 1.2°	
Results	Corrected V Sec	6.479V	Ratio	308.681
	Polarity	Ok	Ratio % Error	2.79%
Test Complete				<input checked="" type="checkbox"/> Auto
				Clear Result
				Evaluate
				Exit

### No-Load / Excitation Current

With TD 5000 optional module

The test is performed using TD 5000 optional module or using the internal high voltage source up to 2kV and then connecting the high AC voltage source to the test target. Input parameters are: the tap number, the type of Tap changer, the test voltage and the frequency. The test set applies the high voltage and measures the output current during the test.

The display shows:

- The test voltage
- The current and the phase shift (introductive, resistive, capacitive)
- The power losses
- The reactance

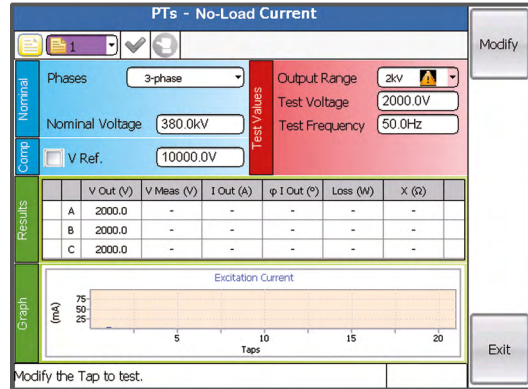

### Short-Circuit Impedance

The test is performed applying low AC current to the winding under test, while other windings are short-circuited and measuring the associated voltage and phase shift.

Input parameters are: the test current and frequency, the type of winding and the phase under test. It is also possible to compensate the test temperature. The test set measures the output voltage and computes the related parameters. The display shows:

- Phase shift; the power loss; the R, X, Z and inductance of the transformer
- Short-circuit impedance in Per Unit

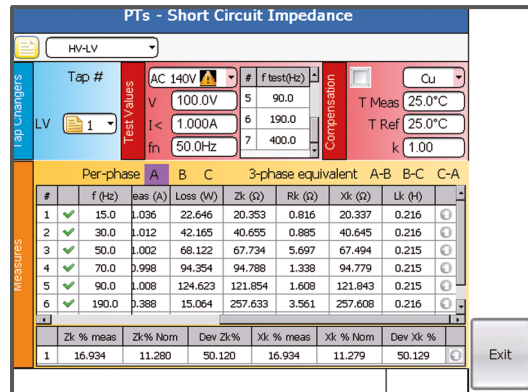

### Power Factor, Capacitance and Tan Delta

With TD 5000 optional module

The test is performed using the TD 5000 optional module and then connecting the high AC voltage source to test target.

Input parameters are: Winding, test voltage and frequency, test mode and the nominal capacitance, PF, DF.

The display shows the following data:

- Test voltage, current and frequency
- Capacitance
- Tan Delta and power factor (absolute or percentage values)
- Power data: active, reactive and apparent
- Impedance: module, argument and components
- It is also possible to apply automatic temperature compensation in the range 5 ÷ 60°C with reference temperature 20°C
- It is also possible to calculate some equivalent parameters at different voltages (for example watt loss and current AT 10kV)

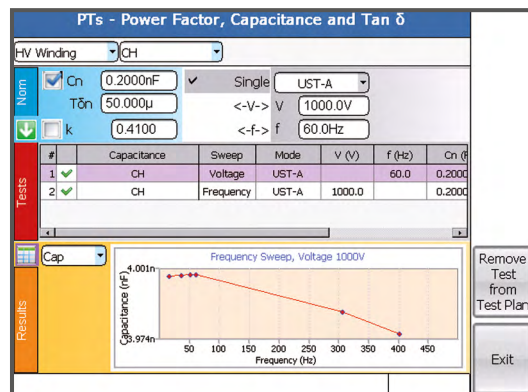

## Breaking and Relay Testing

### CB - Primary and Secondary Relay Tests

With BUX 3000 optional module

The selection allows to inject the test parameter and measuring the relay threshold and trip delay of a breaker or of a relay. It is also possible to measure external voltages and currents. With the option BUX 3000 it is possible to perform high current tests, up to 3000 A. Input parameters are: current range, output current, output voltage and frequency. It is possible to enable the time measurement on the digital input or on the fall of the applied current (breaker tests) and to set the type of digital input (wet or dry).

The display shows the following data:

- Test current or test voltage
- Trip time
- Closing time
- External voltage and current measurements

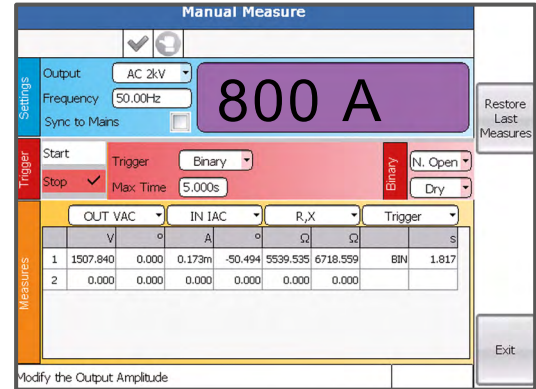

## Circuit Breaker Testing

### Power Factor, Capacitance and Tan Delta

With TD 5000 optional module

The test is performed using the TD 5000 optional module and then connecting the high AC voltage source to test target. Input parameters are: Winding, test voltage and frequency, test mode and the nominal capacitance, PF, DF.

The display shows the following data:

- Test voltage, current and frequency
- Capacitance, Tan Delta and power factor
- Power data: active, reactive and apparent
- Impedance: module, argument and components

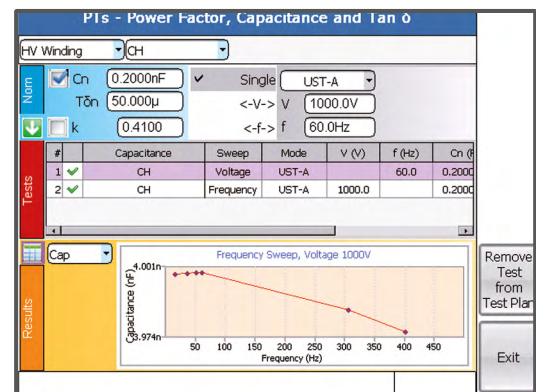

## Ground Resistivity and Resistance

### Soil Resistivity

The test of soil resistivity is performed applying AC voltage to the current spikes and measuring the injected current and the voltage across the voltage spikes. For the resistivity test, input parameters are: voltage range, test current, test frequency.

The display shows: location, probes distance, output voltage, voltage between probes, output current, corresponding resistivity, evaluation.

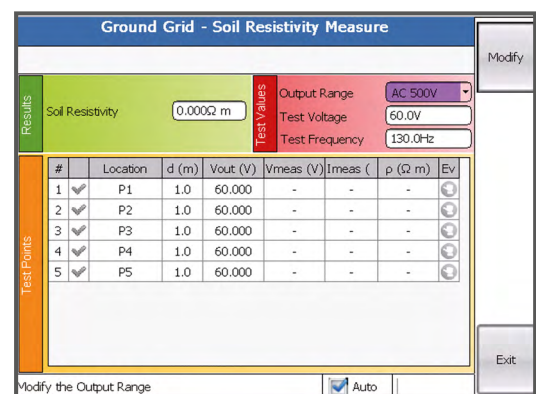

### Ground Grid Resistance

The test of ground grid resistance is performed applying current between the ground grid and the auxiliary ground spikes. With the STLG option the test is performed using an overhead line to connect to the remote ground.

For the resistance test, input parameters are: output voltage range, test current, test frequency. The display shows: test probe distance, output voltage, test probe voltage, output current, phase shift, earth resistance, evaluation.

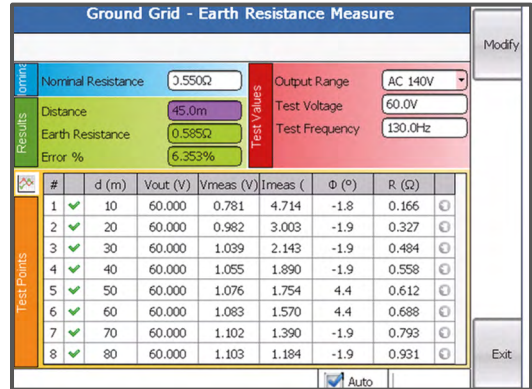

### Step and Touch Voltages

The step and touch voltages test is performed applying current between the ground grid and the auxiliary ground spikes and measuring the step or touch voltage with the test probes. With the STLG option, the current generation is performed using an overhead line to connect to the remote ground. Thanks to the STLG option, higher test currents can be achieved. Input parameters are: substation fault current, fault clearance time, parallel resistance on the test probes. Other selections are: output voltage range, test current, test frequency. Last, the operator selects the measurement mode: manual or on STS and the reference standard.

The display shows the following data: test current, location description, location coordinates, measured voltage, voltage in case of actual fault.

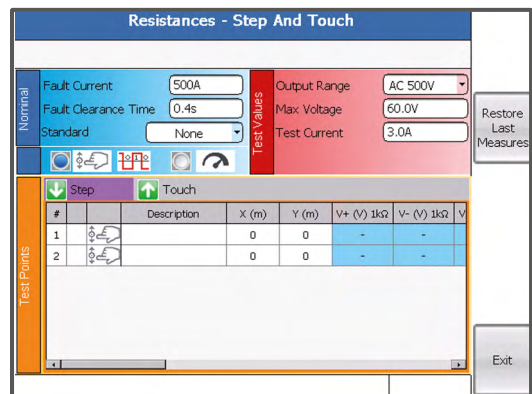

### Transmission Line Parameter Measurement

#### Line Impedance

The line impedance test has the purpose of verifying the computed value of the Earth coefficient KL for the HV overhead lines. This is a critical parameter for the setting of a distance relay: a wrong value causes the false fault location. The test is performed injecting current into the lines, in many modes: line to line, three lines to ground, with or without current in parallel lines. With the STLG option, the current generation can be performed even in presence of induced voltages. The device measures the injected current and the corresponding voltage drop and phase shift. Input parameters are: maximum test voltage and test current. Other parameters are the line material and the test temperature. Tests are performed at frequencies ± 5 Hz with respect to the line frequency, in order to remove the noise. To the left, the display shows the measured and computed values of the impedances; to the right, the computed corrective factors.

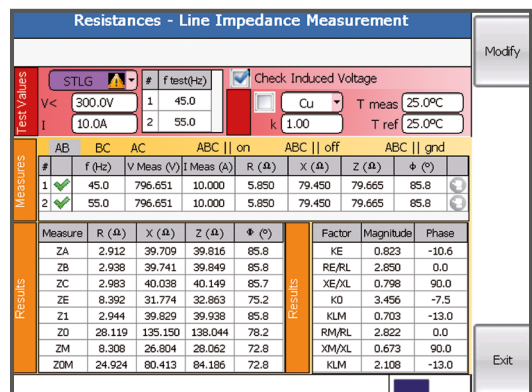

## Other Functions

### Pads Software

The PADS software is a powerful application, included in the TDMS software, which provides connectivity to the instruments of the STS family. The software performs various tasks, such as:

- Edit and upload to the instrument the test headers
- Create and modify plans containing one or more tests
- Optionally remote control of the execution of test plans (start, interruption, results assessment)
- Download and save results of tests previously performed by the instrument
- Open and save results on the PC
- Print test results
- Export test results (excel, CSV, DOC, RPT, PDF, JPEG, XML format).

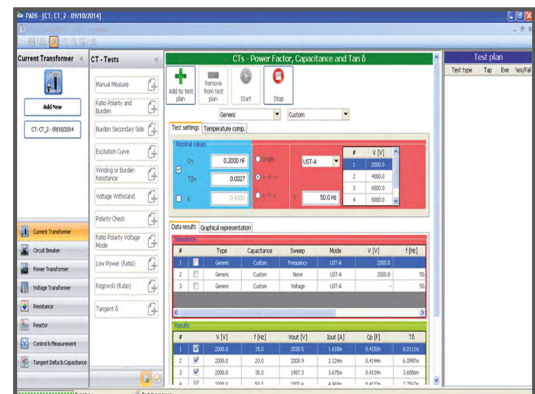
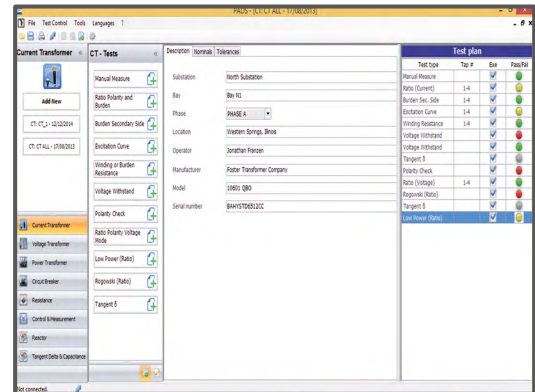



## STS 4000 Specification

### Generator Output

The internal generator has four outputs: Low AC current, Low DC current, High AC voltage, Low AC voltage. Output adjustment is automatically performed once the test has been set. The generated frequency can be userdefined or synchronized to the supply frequency (with optional power line synchronizer).The following specification applies to the separate use of these outputs.

#### High AC Voltage output \*\*

The high AC voltage output is isolated by a HV switch inside the test set. This switch is closed only when the operator selects a high-voltage test, after the enable key is turned ON and after the START button is pressed. Three voltage ranges are available.

MAX VOLTAGE OUTPUT V	CURRENT OUTPUT A	OUTPUT POWER VA	MAX TEST DURATION S	FREQUENCY Hz
2000	1.25	2500	60	15 to 500
2000	1	2000	130	15 to 500
2000	0.5	1000	> 2 hours	15 to 500
1000	2.5	2500	60	15 to 500
1000	2	2000	130	15 to 500
1000	1	1000	> 2 hours	15 to 500
500	5	2500	60	15 to 500
500	4	2000	130	15 to 500
500	2	1000	> 2 hours	15 to 500

- Output connection: two HV safety sockets
- Measurement accuracy: < 0.05% of the reading, < 0.05% of the range
- Phase error: 0.1° (2000 V range)

The test set measures the current generated by the HV output.

CURRENT RANGE A	ACCURACY	PHASE ERROR
5	< 0.2% reading < 0.05% range	< 0.1°
0.5	< 0.05% reading < 0.05% range	< 0.1°
0.05	< 0.1% reading < 0.1% range	< 0.2°

Notes:

- Accuracy values refer to the internal measurements of the outputs
- Accuracies are typical values
- Output power is reduced with the supply of 110 V
- The output amplitude may decrease for frequency below 50 Hz and above 200 Hz

\*\*Output not available on the STS 3000light and TDX 5000 models.

#### Low AC current output \*\*

- Maximum output current: 6 A or 3 A AC
- Maximum output voltage: 70 V AC or 140 V AC
- Maximum output power: 360 VA
- Connection: two safety 4 mm banana sockets
- Frequency range: 15 - 500 Hz

#### Low DC current output \*\*

- Maximum output current: 6 A DC
- Maximum output voltage: 65 V DC
- Maximum output power: 360 W
- Connection: two safety 4 mm banana sockets

#### Low AC Voltage output \*\*

- Voltage range: 140 or 70 V AC
- Output power: 420 VA
- Frequency range: 15 - 500 Hz
- Connection: two safety 4 mm banana sockets

#### Output frequency

- AC output frequency range: 15 to 500 Hz
- Frequency resolution: 10 mHz



## Measuring Inputs

### Current and Voltage

It is possible to meter the current and the voltage of an external generator. Three metering groups are available:

- AC or DC current, up to 10 A
- AC voltage, with two connections:
  - High range, up to 300 V AC
  - Low range, up to 3 V AC
- DC voltage, up to 10 V DC

The selected input is shown in the front panel by an LED

### Resolution and Accuracy

INPUT	RANGE reading & range	ACCURACY
AC CURRENT	1 A; 10 A	<%0.05 <%0.05
DC CURRENT	1 A; 10 A	<%0.03 <% 0.08
HIGH AC VOLTAGE	300 mV; 3 V;	<%0.15 <%0.05
	30 V; 300 V	<%0.05 <%0.05
LOW AC VOLTAGE	30 mV	<%0.1 <%0.25
	300 mV	<%0.08 <%0.08
	3 V	<%0.03 <%0.08
DC VOLTAGE	10 mV; 100 mV	<%0.05 <%0.15
	1 V; 10 V	<%0.03 <%0.08

### Binary Input - Timer

The test set allows testing protection relays. In this mode of operation, the test current or voltage can be ramped or stepped. As the output changes, a timer is started; the timer stops as the Digital input senses that the relay has tripped or the output cut is cut. Characteristics of the Digital input:

- The input may be selected as Normal Open, Normal Closed
- The timer can start from an analog input ( current or voltage)
- The timer can start and stop at the changing of the digital input, both dry or wet contact
- Type of input: either dry or under voltage. Maximum input: 300 V AC or DC
- Voltage thresholds: 5 V, 24 V, 48 V or > 80 V
- Timer resolution: 1 ms

### Phase Angle

The test set measures the phase angle between the two AC selected parameters which are used during the test.

MEASUREMENT	RANGE	RESOLUTION	ACCURACY
PHASE	0 - 360	0.01°	< 0.1°

### OTHER MEASUREMENTS:

Starting from the internal and external measurements, the test set computes the following parameters:

RATIO	POLARITY
BURDEN	KNEE POINT
RESISTANCE	

For the CT, VT and PT ratio measurement, the following applies.

- Range: 0 to 9999
- Resolution: 1
- Accuracy: <0.15% of the reading <0.15% of the range

### Resistance measurement

For the resistance test, the following applies:

SOURCE	RANGE	ACCURACY
LOW DC CURRENT 6 A	100 Ohm to 10 Ohm	< 0.3% < 0.2%
DC V METER	100 Ohm to	< 0.6%
	20 kOhm	< 0.5%

Accuracies are typical values.

## Colour Display

The large graphic display has the following characteristics:

- Pixels: 640 x 480, coloured
- LCD type: TFT
- View area: 132 x 99 mm
- Backlight

## Other Characteristics

### Communication interfaces

- ETHERNET for the PC connection
  - USB port for the USB key
- Interfaces to external modules:
- Commands to TD 5000 and STCS
  - Alarms to a flashing light
  - Remote start input

### Mains supply

100-230 V ± 15% (85 ÷ 264, 5v); 47÷63 Hz.

Maximum supply current: 16 A

Standard plug: shuko, other plugs: on requirement.

Dimensions: 450 (W) x 400 (H) x 230 (D) mm

Weight: 22 kg

## Applicable Standards

The test set conforms to the EEC directives regarding Electromagnetic Compatibility and Low-Voltage instruments.

A) Electromagnetic Compatibility: Directive no. 2004/108/EC. Applicable Standard : EN61326-1:2006

B) Low Voltage Directive: Directive n. 2006/95/EC. Applicable standards: CEI EN 61010-1:2010. In particular:

- Input/output protection: IP 2X - IEC69529; IP 4X for HV output
- Operating temperature: -10° to 55 °C; storage: -20 °C to 70 °C
- Relative humidity: 5-95% without condensing.

Altitude: < 2000 m

## Accessories Supplied

### Connection Cables

- One mains supply cable, 2 m long
- One grounding cable, 6 m long
- One interface cable for the USB port
- One ETHERNET interface cable
- One USB pen drive
- Two high-voltage connection cables, 6 m long (10 m long optionally), 5 kV, with earth screen
- Six connection cables (three red and three black,) 2.5 sq. mm, 6 m long (10 m long optionally), for the connection of: DC current output, low AC voltage output and digital input
- Four clamps to connect low voltage or low current or measurements, two red and two black, with a short cable terminating with a banana socket
- Six “Kelvin” clamps, with two sockets each, to connect generator and measurement
- One cable for the 3 V measurement connection, shielded, 6 m long (10 m long optionally)
- One cable for the 10 V measurement connection, shielded, 2.5 sq. mm, 6 m long (10 m long optionally)
- Four crocodiles for measurements connections (two red and two black)
- One short cable, red, for the current measurement
- One connection cables transport case
- Extra long connection cables for EHV equipment (> 700 kV) can be supplied optionally

### Transport Case

The transit case allows delivering STS 4000 with no concern about shocks up to a fall of 1 m. This case is supplied with handles and wheels.

### STSA and STSA 3V - Surge Arresters

These devices apply to all STS models. They limit voltage surges generated at 10 V or 3 V voltage measurement inputs respectively if, during the winding resistance test, the circuit is erroneously opened. They include a surge arrester plus two fuses.



## Optional Accessories

### BUX 2000 - BUX 3000 - BUX 5000 High Current Booster

The three optional current boosters BUX 2000, BUX 3000 and BUX 5000 allow performing tests up to 2000A, 3000 A or 5000 A. The option is made of a module, which incorporates:

- A power transformer, which generates a low-voltage, high-current output
- A metering CT, which measures the output current, and sends the metering to STS 4000



Option features:

#### BUX 2000 / BUX 3000

TEST CURRENT A	OUTPUT POWER VA	TEST DURATION s
500	700	INFINITE
1000	1500	60
2000	5000	25

#### BUX 5000

TEST CURRENT A	OUTPUT POWER VA	TEST DURATION s
1000	900	INFINITE
2000	2400	300
3000	4800	60

TEST CURRENT A	OUTPUT POWER VA	TEST DURATION s
1000	700	INFINITE
2000	1500	300
3000	2700	30
4000	4200	20
5000	5500	10

- Frequency: 15 Hz - 500 Hz\*
- Weight: BUX 2000 18 kg, BUX 3000 15 kg, BUX 5000 19 kg without current cables and clamps
- Dimensions for models BUX 2000 and BUX 3000: external diameter 190 mm; height 120 mm

- Dimensions for model BUX 5000: external diameter 200 mm; height 170 mm

All high current boosters are supplied with:

- High current cable, made of 4 cables, 95 sq. mm, 1.2 m long, with 2 high current clamps for BUX3000
- 4 cables, 95 sq. mm, 2 m long, with 2 high current clamps for BUX 2000
- 12 cables, 95 sq. mm, 0.8 m long, with 4 high current clamps for BUX 5000
- One power supply cable, 20 m long
- One measurement cable, 20 m long, with the output current measurement
- In addition, the option is provided with 2 metering cables for the connection of the CT secondary

\* The output amplitude may decrease for frequency below 50 Hz and above 60 Hz

### STCS Plus Switch Module

The external module **STCS Plus** allows to run automatically and with a single set up any kind of tests on power transformer. Only two multipolar cables are needed, one for the primary side and one for the secondary side, each placed on its own cable reel in order to have a unique and complete connection to the power transformer.

The option includes also two junction boxes that allow an easy connection of the multipolar cables to the transformer bushings.

One of these boxes is equipped with a switch high current for automatic measurement of the short circuit impedance. The lid of **STCS PLUS** is removable.

**STCS PLUS** optional set, allows to perform the following tests automatically and with a single setup connection:

- Ratio per tap
- No load current
- Vector group
- Short-circuit impedance
- Leakage reactance
- Winding resistance
- OLTC dynamic test
- Demagnetization



STCS PLUS

Advantages:

- Fast measurement and single set-up for all the tests
- Low probability of connection errors

The STCS Plus option also includes:

- Connection to each of the activated generators on STS 5000 or STS 4000 for performing a specific test. Voltage test maximum 400 V, maximum test current 6 A

- Connection to each of the measurement inputs activated to STS 5000 or STS 4000 for the execution of a specific test
- Connections for controlling the high current switch present in one of the junction boxes
- Two relays for the Tap Changer Up and Down commands up to 240 V, 1 A AC, or up to 110 V, 0.1 A DC
- Multipolar connector STS EXT. DEVICE for communication with STS 5000 or STS 4000



STCS PLUS + JUNCTION BOX

STCS plus can be supplied with the most suitable cable set according to the dimensions of the transformer: transformers up to 500 kV or up to 150 kV. Both configurations can be supplied with standard-length multipolar cables (15 meters) or with multipolar cables of extended length (30 meters) for combined use with equipped vans.

### STCS Switch Module

The external module STCS allows performing automatically the following PT tests: ratio per tap; winding resistance; OLTC dynamic test. The connection to the transformer under test, to STS and to the measurement taps is performed just once; then, all transformer tests are performed without interruptions.



STCS

This option applies to STS 5000 and STS 4000.

Device characteristics:

- Inputs from STS: 300 V AC or 6 A DC
- Tap Changer Up and Down: 240 V AC or 110 V DC
- Outputs to STS measurements: 300 V AC or DC and 10 V DC

The option comes complete with the following connection cables (which can also be ordered separately):

- 10 Coaxial cables, for low voltage connections
- 2 Cables, 2 m long, for the connection of the STS HV output to the STCS input

- 6 Cables, 2 m long, for low voltage connections
- 1 connection cable to the EXT. DEVICES connector of STS
- 6 converters, from banana to terminator
- 8 “Kelvin” type clamps, for the connection of the PT generator and meter
- 1 Ground cable, 6 m long
- 2 Transit cases

### 20A DC Booster - Winding Resistance Test

The 20A DC STCS booster allows to perform resistance tests on a PT with a current up to 20 A DC, instead of the 6 A DC provided by STS 5000 or STS 4000. The option applies to STS 5000 and STS 4000 and must be connected to STCS, which controls it.

Booster characteristics:

- Maximum output current: 20 A DC
- Maximum power on output sockets: 400 W
- Current output switch: controlled by STCS
- Current output amplitude: controlled by STS 5000 or STS 4000

The option comes complete with all the necessary connection cables.



20 A DC BOOSTER

### STDE Power Transformer Demagnetizer

This option allows neutralizing the residual magnetization of the power transformer core after the winding resistance test.

The principle of the option is to apply a constant current of alternate polarities to the transformer winding, as per the IEEE 0062 1995 standard.

Device characteristics.

- Constant current, voltage limited generator
- Maximum test current: 7 A DC
- Maximum test voltage: 70 V DC
- Output current stability: better than 0.5% of the rated value
- Automatic current direction reversal

The option is connected to STS via the control connector, which supplies its circuits and issues the generation commands.

The power is taken from the STS low-power DC current generator.

- Housing: plastic case with handle



STDE

### STLG - Module Ground Testing and Line Impedance Measurement

The option allows performing both the measurement of: soil resistivity, ground grid resistance, step and touch tests and overhead lines zero sequence and mutual coupling coefficients. This option applies to STS 5000 and 4000 models.

STLG is a high power transformer, which increases the output current. A high current switch allows selecting the desired current range. A voltage meter displays the generated voltage. The option takes its power from the EXT. BOOSTER connector of STS. Output current and voltage are metered and sent back to STS measuring inputs; a third output allows STS to know the selected range.

Device characteristics are the following:

- Input: from STS 5000, via the booster connector
- Output current ranges: 11, 22, 35, 55, 105 A AC
- Output power: 1800 VA steady; 5200 VA peak for 10 s
- High current range selector switch
- Analogue output voltage meter. Meter range: 600 V AC
- Outputs to STS 5000: selected current output range, output current and output voltage.

All necessary connection cables are included in the option. Current clamp provided: 400 A range.

Housing: black plastic case, with handles.

Weight: 25 kg.

Dimensions: 23 x 33 x 44 cm.



STLG

## STSG - Safety Grounding Module

During tests, STLG is connected to the overhead line to be tested. The purpose of the STSG optional device is to protect the operator against possible high voltage spikes.

STSG incorporates three voltage suppressors and one high current switch, to connect three-Safetyelines in parallel. This option applies to STS 5000 and 4000 models, in conjunction with STLG. Option characteristics:

- Nominal AC spark-over voltage: 1000 V rms
- Impulse spark-over voltage: 2000 V peak
- Short-circuit proof with 25 kAeff / 100 ms; 36 kAeff / 75 ms
- Connection via three cylindrical ball studs 16, 20 or 25 mm diameter. The ball diameter must be specified at order
- Metal aluminum box with handle
- Weight: 9.1 kg
- Dimensions: 41 x 21 x 13.5 cm
- Grounding cable included: 95sq.mm, 2m



STSG

## Ground Grid Test Accessories Kit

This option applies to STS 5000 and 4000 models. The option is the kit of connection cables, auxiliary spikes and other accessories that allows connecting STS or STLG to the testing devices and performing all types of tests. The kit includes:

- Four earth spikes for the soil resistivity test and for the earth resistance test
- Two auxiliary earth spikes, for tests in small sites
- Three cables, wound on wheels, 200 m long
- One mains synchronizer device, to synchronize the STS generation to the mains
- Two test probes for the step and touch test
- One voltage meter, digital, type true RMS, for the earth resistance and step and touch tests
- One resistor box for the step and touch test

This kit is not supplied with Line Impedance



GROUND GRID TEST ACCESSORIES KIT

## Line Impedance Kit

The kit is made of STLG - Line and Grid module and STSG - safety grounding module, without the line and grid accessories.

## PLCK Polarity Checker Module

Checking the correct connection of CT's and VT's to protection relays is a problem because relays can be hundreds of meters away from the transformer. PLCK easily solves the issue. When this test is started, STS 5000 generates a special, not sinusoidal waveform, which is injected into the connection cables. The polarity check is easily performed by connecting it at the relay site. PLCK has two lights: green and red. The green light turns on when the polarity is correct; the red light turns on when the polarity is wrong.



PLCK Polarity checker

## Remote Safety Switch

If it is desired to start the test remotely from the test set, the optional switch allows to do it, up to the distance of 20 m, which is the length of the cable provided.



REMOTE SAFETY SWITCH

## Current Clamp

The current clamp allows to avoid the opening of the secondary current circuit when performing the primary test of CT burden. The clamp ratio is 1000/1; maximum primary current 100 A and maximum cable diameter 12 mm.

### Warning Strobe Light

The warning strobe light alerts when the test is completed, or when there are alarms. The light is self-powered, and turns on (flashes) upon the test set command. A siren is also included.

### Transport Case

Transport cases for STS 5000, TD 5000 and BUX 3000 are available; all of them allow transporting the device with non concern about shocks or falls up to 1 m. The case is complete with handles and wheels.



HEAVY DUTY TRANSPORT CASE

### Foldable Trolley

The trolley eases the transport of STS 5000, especially when the optional TD 5000 has to be used too. The trolley is designed to host both instruments and also the high-voltage cable for TD 5000.



FOLDABLE TROLLEY

### SFRA 5000 - Sweep Frequency Response Analyzer

SFRA 5000 is a stand alone sweep frequency response analyzer for the high accuracy transformer analysis and integrates the STS and TD 5000 family test sets. The SFRA 5000 offers both high precision and portability in a single package, providing all the accessories required for fast, easy to use, reliable and repeatable measurements. SFRA 5000 is provided with its own embedded software, giving the possibility to the engineer to zoom into a portion of the sweep in order to inspect any differences in the plot in more detail during or after a sweep.



SFRA 5000

### Optional Software

#### PADS - Power Apparatus Diagnostic Software

PADS - Power Apparatus Diagnostic Software is a powerful software application, included in TDMS software, that allow the remote control of the STS family: STS 5000, STS 4000, TDX 5000. These devices allow performing tests of: CTs, VTs, PTs, CBs and almost all other power devices in electrical substation.

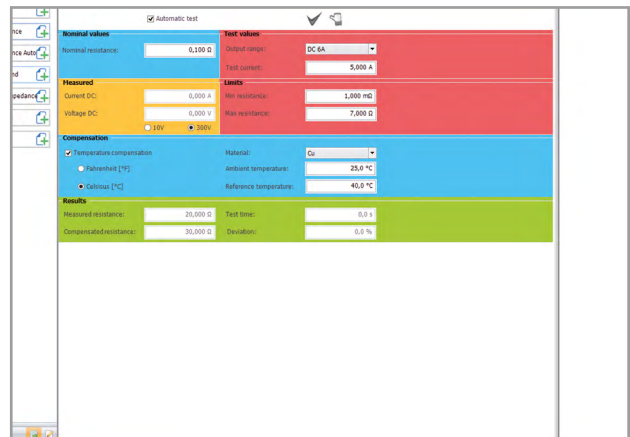

PADS SOFTWARE

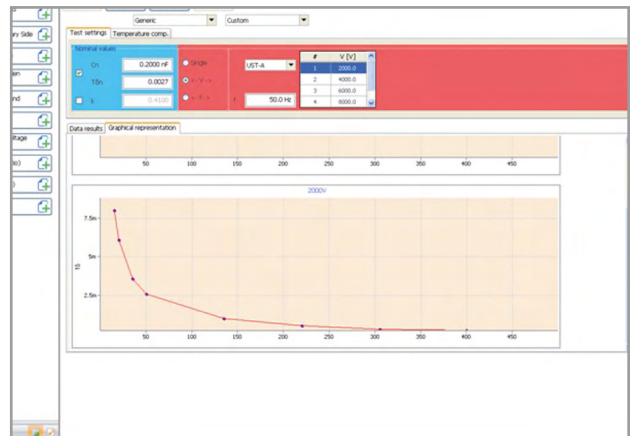

PADS SOFTWARE

## Capacitance and Tan Delta Diagnostic System for High - Voltage Apparatus

- Optional module for STS 5000 and STS 4000 test set, standard module for STS 3000 light
- Tan Delta, capacitance, dissipation factor measurements and for exciting current test
- Output voltage from 12 V up to 12 kV
- Variable output frequency: 1 - 500 Hz
- PADS - Power Apparatus Diagnostic Software for automatic testing, assessment and report
- Compact and lightweight
- Patented technology

### Application

The following table lists the tests that can be performed on power transformers and high-voltage apparatus:

- Tan Delta (or dissipation factor DF): from 0 to more than 100%
- Capacitance: from 1 pF to 200  $\mu$ F
- Power factor : from 0 to 100%

### General Characteristics

The high-voltage generator TD 5000 performs the measurement of the Tan Delta, of the dissipation factor and of the capacitance of a transformer or of a bushing, at the frequency of the mains or in a wide frequency range. Optionally, with the TTR module (optional), it is possible to measure the transformer ratio at high voltage. The measurement is performed by the module, which is equipped with a patent pending technology.

The measurement circuitry incorporates a reference high voltage capacitor, rated 200 pF, with a tan delta better than 0.005%, plus a reference resistor bridge, with accuracy better than 0.01%, and thermal drift less than 1 ppM/°C. The patented circuitry and the variable frequency output make test results immune from external noise.

Before each test, the TD 5000 automatic check and calibrate itself with the internal reference capacitor.

Available test selections:

- Ungrounded: UST-A; UST-B; UST A+B
- Grounded: GST; GSTg-A; GSTg-B; GSTg-A+B

TD 5000 is powered and controlled by STS 5000, STS 4000. Type of generator: HV generator with electronic control.

The generated signals are independent from the mains.



TD 5000



### Generator Characteristics

MAX VOLTAGE OUTPUT V	CURRENT OUTPUT A	MAX OUTPUT DURATION T Max	FREQUENCY Hz
12000	300 mA	240 s	1 to 500
12000	125 mA	> 1 hour	1 to 500
12000	100 mA	steady	1 to 500

Note<sup>1</sup>: the maximum voltage output may decrease for frequency below 40hz and above 400Hz.

Note<sup>2</sup>: at 10 kV the output (current value and duration) has the same characteristic.

Maximum power: 3.6 kVA

Voltage and current output metering accuracy and resolution.

INTERNAL MEASURE	RESOLUTION	TYPICAL ACCURACY ±% (rdg) ±% (rg)	GUARANTEED ACCURACY ±% (rdg) ±% (rg)
12000 VAC	1V	± 0.2% ± 0.5 V	<0.3%+1V
5 A AC (@ inputs A or B > 10 mA)	0.1 mA	± 0.2% ± 0.1 mA	<0.5%
<10 mA AC (@ inputs A or B)	0.1µA	± 0.2% ± 0.1 µA	<0.3%+0.1µA

- Frequency range: 1 to 500 Hz
- Connections: by a double shielded HV connector, two Ground sockets (case and external shield of HV cable), and two measurement sockets (A and B)

### Test Measurements

#### Capacitance

- Measurement range 1: from 1 pF to 5µF. Resolution: 6 digits. Accuracy, typical: ± 0.03% of the value ± 0.1 pF; guaranteed: < 0.1% of the value +1pF (from 45 to 70 Hz)
- Measurement range 2: from 5 µF to 200 µF. Resolution: 6 digits. Accuracy, typical: ±0.1% of the value ±0.1 nF, guaranteed: <0.5% of the value ±1 nF

#### Tan Delta or Dissipation Factor DF

- Measurement range 1: from 0 to 10% (capacitive). Resolution: 5 digits; accuracy, typical: 0.05% of the value ± 0.005 %; guaranteed: 0.1% of the value ± 0.005 % (from 45 to 70 Hz, current < 10 mA)
- Measurement range 2: from 0 to 100%. Resolution: 5 digits; accuracy, typical: 0.3% of the value ± 0.01 %; guaranteed: 0.5% of the value ± 0.02 %
- Measurement range 3: over 100%. Resolution: 5 digits; accuracy, typical: 0.5% of the value ± 0.03 %; guaranteed: 0.8% of the value ± 0.05 %

#### Power Factor PF (or cos (φ))

- Measurement range 1: from 0 to 10% (capacitive). Resolution: 5 digits; accuracy, typical: 0.05% of the value ± 0.005 %; guaranteed: 0.1% of the value ± 0.005 % (from 45 to 70 Hz, current < 10 mA)
- Measurement range 2: from 0 to 100%. Resolution: 5 digits; accuracy, typical: 0.3% of the value ± 0.02 %; guaranteed: 0.5% of the value ± 0.02 %

#### Impedance

From 1kOhm to 1400 MOhm. Accuracy, typical 0.3% of the value ± 0.1%, guaranteed <0.5% of the value. Resolution: 6 digits.

#### Power (Dielectric losses)

Measurement ranges: from 0 to 10 kW, 100 kW, 1 MW. Resolution (6 digits): 0.1 mW; accuracy: <0.5% of the value ± 1 mW. The same ranges and accuracies are applied to reactive and apparent power measurements.

#### Inductance

- Measurement range 1: from 1 H to 10 kH. Resolution (6 digits): 0.1 mH; accuracy, typical: 0.3% of the value ± 0.5 mH; guaranteed: 0.5% of the value
- Measurement range 2: from 100 H to 10 MH. Resolution (6 digits): 1 H; accuracy, typical: 0.3% of the value; guaranteed: <0.5% of the value

#### Excitation Current

- Range 1: 10 mA. Resolution: 0.1 µA; accuracy, typical: 0.2% of the value ± 0.1µA; guaranteed: 0.3% of the value ± 0.1µA
- Range 2: 300 mA. Resolution 1 mA; accuracy, typical: 0.2% of the value ± 1 mA; guaranteed: 0.5% of the value ± 0.5% of the range

#### Output Frequency

AC output frequency range: 1 to 500 Hz.

#### Max Interference Conditions at Line

- Electrostatic: 15 mA rms of the interference current into any lead or cable with no loss of measurement accuracy. Applicable to a maximum ratio of interference current to specimen current 20:1
- Electromagnetic: 500 µT, at 50/60 Hz in any direction

TD 5000 Dimensions: 440 (W) x 345 (H) x 210 (D) mm

Weight: 25 kg

### Standard Accessories

#### Testing Cables

The option comes complete with the following connection cables:

- 1 yellow-green connection cable, 6 m long, for the ground connections, terminated with terminator on one side, and with a clamp on the other side
- 2 yellow-green connection cables, 1 m long, for the ground connections, terminated with terminators
- 1 yellow-green connection cable, 2 m long, for the ground connections, terminated with terminators
- 1 power cable to the BOOSTERS connector of STS, 1 m long
- 1 power cable to the BOOSTERS connector of STS, 2 m long
- 1 High voltage connection cable, 20 m long, 25 kV, with earth screen, for the connection to the device under test, terminated on the device side with an isolated banana plug, and on the TD 5000 side with two plugs: one for the HV and the other one for the ground. The cable is mounted on a wheel
- 1 clamp, 25 mm opening, with a connector which mates with the HV cable
- 1 bigger clamp, 40 mm opening, with a connector which mates with the HV cable
- 2 shielded connection cables, 20 m long, for the connection to the metering points. Terminated on the TD 5000 side with the metering connector, and on the device side with a banana plug. Cables are mounted on wheels

- 2 clamps, 25 mm opening, terminated with banana sockets, which allow connecting to the metering point
- 2 Kelvin type clamps, 40 mm opening, with banana plugs, which allow connecting to the metering point
- 1 hot collar cable, 1m long, with connector
- 1 signals connection cable to the EXT. DEVICES connector of STS, 1 m long
- 1 signals connection cable to the EXT. DEVICES connector of STS, 2 m long
- 1 connection cables transport case
- Extra long connection cables for EHV equipment (> 700 kV) can be supplied optionally

### Foldable Trolley

The trolley eases the transport of TD 5000 and is designed to host both instruments and also the high-voltage cable.

### Transport Case

The transit case allows delivering TD 5000 with no concern about shocks up to a fall of 1 m.

## Optional Accessories

### RCTD - Compensating Reactor

This module is useful for testing Tan Delta in rotating machines with TD 5000 and allows increasing the test current and getting the maximum test voltage with high capacitive burdens. Each RCTD is composed by two inductors with a nominal value of 40H and a steady current of 0.4A. The maximum current on each inductor can be up to 1A for more than 10s. The inductors can be connected in parallel on the load in order to increase the test frequency. It is possible to connect two RCTD in parallel in order to have three or four inductors connected together (2 x 80 H total).



RCTD

### CAP - CAL Calibrator Module

Purpose of the calibrator is to check the correctness of TD 5000 measurement. The calibrator includes an extremely high accuracy high voltage capacitor, which comes with a certificate issued by ISA lab.



CAP-CAL

### Stoil Cell for the HV Test of the Dielectric Oil

The option allows testing that the oil characteristics of isolation are met and that there is no contamination.

The option is made of a suitable glass container with electrodes; the electrodes are connected to the option TD 5000 for the test execution. The test result, displayed by STS 5000, is the oil Tan Delta. Cell characteristics are the followings:

- Maximum test voltage: 12 kV
- Cell volume: about 1l
- Capacitance of the empty cell: 60 pF



OIL CELL

### Digital Thermo Hygrometer

A number of tests performed by STS, such as coil resistance, Tan Delta are influenced by temperature and humidity. The option allows measuring these parameters and to input them into the test settings. Meter characteristics:

- Temperature range:- 10°C to 60°C
- Temperature measurement accuracy:  $\pm 0.4^\circ\text{C}$
- Humidity measurement range: 5 % to 95% RH
- Accuracy of humidity measurement:  $\pm 2.5\%$  RH, over the whole range
- Dimensions: 141 x 71 x 27 mm. Weight: 150 g

## Ordering Information

CODE	MODULE
10175	STS 5000 - with TDMS software*, standard test cable kit, STSA and heavy duty transport case
37175	
20175	STS 4000 - with TDMS software*, standard test cable kit, STSA and heavy duty transport case
37175	
65175	TDX 5000 with TDMS software*, standard test cable kit and heavy duty transport case
38175	
31175	STS 3000 light - with TD 5000, TDMS software*, standard test cable kit, foldable trolley
11175	
37175	and heavy duty transport case
11175	TD 5000 module for the high-voltage test of Tan Delta for transformers and bushings, supplied with test cables, heavy duty transport case and foldable trolley
39175	
18175	

## Optional Accessories

CODE	MODULE
10176P	PADS software (primary)- Primary, CTs, VTs test module*
10176T	PADS software (trasfo)- Power transformer and Tan Delta test module*
10176F	PADS (full)- Full software suite (includes 10176P & 10176T)*
63175	BUX 5000 - External Advanced Booster up to 5000 A supplied with transport case
50175	BUX 3000 - External Advanced Booster up to 3000 A supplied with transport case
56175	BUX 2000 - External Advanced Booster up to 2000 A supplied with transport case
12175	STCS Circuit switch module and with Cable test kit for STCS
22175	
33175	STCS PLUS switch module
23185	150kV Cable test kit for STCS PLUS
25185	150kV Cable test kit for STCS PLUS for TEST VAN
34175	500kV Cable test kit for STCS PLUS
24185	500kV Cable test kit for STCS PLUS for TEST VAN
32175	20A DC STCS Booster
81175	Step & Touch testing kit: . ST-LG Line & ground grid module (100 A booster) . Cables set for STLG . Heavy duty plastic transport case for STLG . ST-SG Safety grounding module . Heavy duty plastic transport case for STSG . Step & touch, earth resistance/resistivity accessories
84175	Line Impedance testing kit: STLG Line & ground grid module (100 A booster) . Cables set for STLG . Heavy duty plastic transport case for STLG . STSG Safety grounding module . Heavy duty plastic transport case for STSG

## Optional Accessories

CODE	MODULE
72175	Stud 20 mm for Step & Touch testing kit
73175	Stud 25 mm for Step & Touch testing kit
74175	Stud 16 mm for Step & Touch testing kit
19102	Earth Resistance and Soil Resistivity Kit
27175	STDE demagnetizer module
13175	STOIL Cell for the electric test of insulating oil of the transformer
40175	CAP-CAL Calibration module
41175	PLCK - Polarity checker
42175	Remote safety switch
43175	Warning strobe light
44175	Digital thermo hygrometer
47175	RCTD - Compensating reactor for TD 5000 with transport case
48175	Cable test kit for RCTD
16102	Current Clamp 1/1000 Max 100A
90175	SFRA 5000, supplied with cables, software and transport case
15175	Cable test kit with case for STS 5000
14175	Cable test kit for TD 5000
16175	Optional long cable test kit for STS 5000
17175	Heavy duty plastic transport case for STS 5000
18175	Trolley for STS family test sets and TD 5000
19175	Heavy duty plastic transport case for TD 5000
51175	Heavy duty plastic transport case for BUX 3000
52175	BU2000-STC adaptor
57175	Extra long connection cables for EHV equipment

\*PADS-PowerApparatusDiagnosticSoftwareisNOTincludedinto basic unit price. It should be expressly ordered.

ForUSAandGermany,onlySTS3000lightwithTD5000and/orTDX 5000 test sets are available.

## Comparison Table of the STS Family Tests

NO.	TEST OF	TEST DESCRIPTION	STS 5000	STS 4000	TDX 5000
1	CT	Ratio, Voltage mode	✓	✓	NOT AVAILABLE
2	CT	Ratio, polarity and burden with high AC current	✓	WITH BUX 3000	NOT AVAILABLE
3	CT	Burden; secondary side	✓	✓	NOT AVAILABLE
4	CT	Excitation curve	✓	✓	NOT AVAILABLE
5	CT	Winding or burden resistance	✓	✓	NOT AVAILABLE
6	CT	Voltage withstand	✓	✓	NOT AVAILABLE
7	CT	Remote polarity check	✓	NOT AVAILABLE	NOT AVAILABLE
8	CT	Rogowski coil transformers	✓	WITH BUX 3000	NOT AVAILABLE
9	CT	Low power transformers	✓	WITH BUX 3000	NOT AVAILABLE
10	CT	Tan( $\delta$ ) measurements	WITH TD 5000	WITH TD 5000	✓
11	VT	Ratio; polarity	✓	✓	NOT AVAILABLE
12	VT	Burden, secondary side	✓	✓	NOT AVAILABLE
13	VT	Ratio, electronic transformers	✓	✓	NOT AVAILABLE
14	VT	Voltage withstand	✓	✓	NOT AVAILABLE
15	VT	Remote polarity check	✓	NOT AVAILABLE	NOT AVAILABLE
16	VT	Tan( $\delta$ ) measurements	WITH TD 5000	WITH TD 5000	✓
17	PT	Ratio per TAP	✓	✓	NOT AVAILABLE
18	PT	Static and dynamic resistance of Tap Changer contacts	✓	✓	NOT AVAILABLE
19	PT	No load / Excitation current	WITH TD 5000	WITH TD 5000	✓
20	PT	Short circuit impedance	✓	✓	NOT AVAILABLE
21	PT	Tan( $\delta$ ) measurements	WITH TD 5000	WITH TD 5000	✓
22	CB	High DC current micro-Ohmmeter test	✓	NOT AVAILABLE	NOT AVAILABLE
23	CB	Tan( $\delta$ ) measurements	WITH TD 5000	WITH TD 5000	✓
24	VT CB RELAY	Current threshold and timing	✓	✓	NOT AVAILABLE
25	R	Ground resistance and resistivity	✓	✓	NOT AVAILABLE
26	R	Step and touch voltages	✓	✓	NOT AVAILABLE
27	L	Measurement of line impedance and of the related parameters	✓	✓	NOT AVAILABLE
28	Capacitor Banks	Measurement of the capacitance	WITH TD 5000	WITH TD 5000	

**ALTANOVA**  
GROUP  
[www.altanova-group.com](http://www.altanova-group.com)

**TECHIMP**

TECHIMP - ALTANOVA GROUP

Via Toscana 11,  
40069 Zola Predosa (Bo) - ITALY  
Phone +39 051 199 86 050  
Email [sales@altanova-group.com](mailto:sales@altanova-group.com)

**isa**

ISA - ALTANOVA GROUP

Via Prati Bassi 22,  
21020 Taino (Va) - ITALY  
Phone +39 0331 95 60 81  
Email [isa@altanova-group.com](mailto:isa@altanova-group.com)

**IntelliSAW**

IntelliSAW - ALTANOVA GROUP

100 Burrtt Rd  
Andover, MA 01810 (USA)  
Phone +1 978-409-1534  
Email [contact@intellisaw.com](mailto:contact@intellisaw.com)